

# MUR550APF, MURD550PF, MUR550PF, MURF550PF

## SWITCHMODE™ Power Rectifier

These state-of-the-art devices are designed for power factor correction in discontinuous and critical conduction mode.

### Features

- 520 V Rating Meets 80% Derating Requirements of Major OEMs
- Low Forward Voltage Drop
- Low Leakage
- Ultrafast 95 Nanosecond Recovery Time
- Reduces Forward Conduction Loss
- Pb-Free Packages are Available

### Applications

- DCM PFC Designs
- Switching Power Supplies
- Power Inverters

### Mechanical Characteristics:

- Case: Epoxy, Molded
- Epoxy Meets UL 94 V-0 @ 0.125 in
- Weight: MUR550APF: 1.1 Gram (Approximately)  
MURD550PF: 0.4 Gram (Approximately)  
MUR550PF, MURF550PF: 1.9 Gram (Approximately)
- Finish: All External Surfaces Corrosion Resistant and Terminal Leads are Readily Solderable
- Lead and Mounting Surface Temperature for Soldering Purposes: 260°C Max. for 10 Seconds

### ORDERING INFORMATION

Device	Package	Shipping†
MUR550APF	Axial*	500 Units/Bag
MUR550APFG	Axial*	500 Units/Bag
MUR550APFRL	Axial*	1500 Tape & Reel
MUR550APFRLG	Axial*	1500 Tape & Reel
MURD550PFT4	DPAK	2500 Tape & Reel
MURD550PFT4G	DPAK (Pb-Free)	2500 Tape & Reel
MUR550PF	TO-220AC	50 Units/Rail
MUR550PFG	TO-220AC (Pb-Free)	50 Units/Rail
MURF550PFG	TO-220FP (Pb-Free)	50 Units / Rail

†For information on tape and reel specifications, including part orientation and tape sizes, please refer to our Tape and Reel Packaging Specification Brochure, BRD8011/D.

\*This package is inherently Pb-Free.



ON Semiconductor®

<http://onsemi.com>

## ULTRAFast RECTIFIER 5.0 AMPERES, 520 VOLTS

### MARKING DIAGRAMS

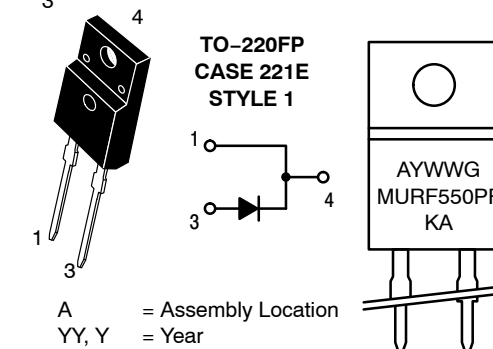
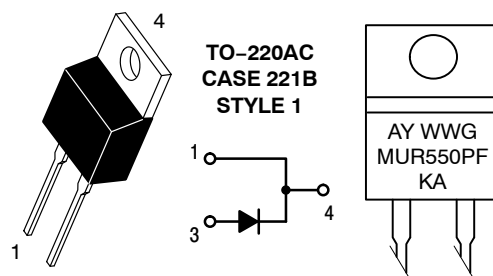
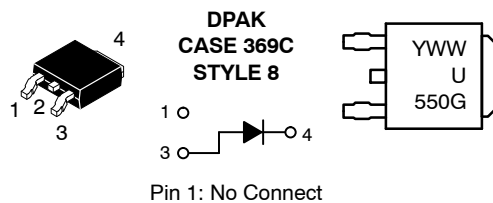
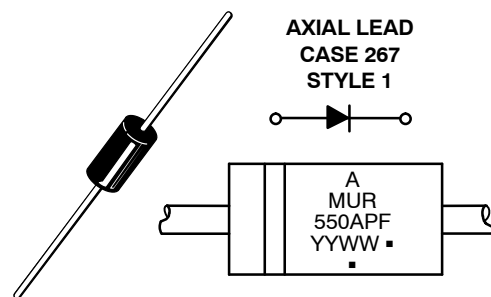

A = Assembly Location  
YY, Y = Year  
WW = Work Week  
▪ or G = Pb-Free Package  
KA = Diode Polarity

(Note: Microdot may be in either location)

# MUR550APF, MURD550PF, MUR550PF, MURF550PF

## MAXIMUM RATINGS

Rating	Symbol	Value	Unit
Peak Repetitive Reverse Voltage Working Peak Reverse Voltage DC Blocking Voltage	$V_{RRM}$ $V_{RWM}$ $V_R$	520	V
Average Rectified Forward Current (Rated $V_R$ ) $T_C = 65^\circ\text{C}$ (Rated $V_R$ ) $T_C = 160^\circ\text{C}$	$I_{F(AV)}$	5.0	A
Non-Repetitive Peak Surge Current (Surge Applied at Rated Load Conditions Halfwave, 60 Hz)	$I_{FSM}$	85 75 100	A
Operating Junction Temperature Range	$T_J$	-65 to +175	$^\circ\text{C}$
Storage Temperature Range	$T_{stg}$	-65 to +175	$^\circ\text{C}$
ESD Ratings: Machine Model = C Human Body Model = 3B	ESD	> 400 >8000	V

Stresses exceeding Maximum Ratings may damage the device. Maximum Ratings are stress ratings only. Functional operation above the Recommended Operating Conditions is not implied. Extended exposure to stresses above the Recommended Operating Conditions may affect device reliability.

## THERMAL CHARACTERISTICS

Rating	Symbol	Value	Unit
Thermal Resistance, Junction-to-Case (Note 1)	$R_{\theta JC}$	2.8 5.75	$^\circ\text{C}/\text{W}$
Thermal Resistance, Junction-to-Ambient	$R_{\theta JA}$	Note 2 62 75	$^\circ\text{C}/\text{W}$

1. Rating applies when surface mounted on the minimum pad sizes recommended.
2. See Note 2, Ambient Mounting Data.
3. 1 inch square pad size on FR4 board.

## ELECTRICAL CHARACTERISTICS

Rating	Symbol	Value	Unit
Maximum Instantaneous Forward Voltage Drop (Note 4) ( $I_F = 5.0\text{ A}$ , $T_J = 25^\circ\text{C}$ ) ( $I_F = 5.0\text{ A}$ , $T_J = 150^\circ\text{C}$ )	$V_F$	1.15 0.98	V
Maximum Instantaneous Reverse Current (Note 4) ( $V_R = 520\text{ V}$ , $T_J = 25^\circ\text{C}$ ) ( $V_R = 520\text{ V}$ , $T_J = 150^\circ\text{C}$ )	$I_R$	5.0 400	$\mu\text{A}$
Maximum Reverse Recovery Time ( $I_F = 1.0\text{ A}$ , $di/dt = 50\text{ A}/\mu\text{s}$ , $V_R = 30\text{ V}$ , $T_J = 25^\circ\text{C}$ )	$t_{rr}$	95	ns

4. Pulse Test: Pulse Width = 300  $\mu\text{s}$ , Duty Cycle  $\leq 2.0\%$ .

NOTE 2 — AMBIENT MOUNTING DATA

Data shown for thermal resistance junction-to-ambient ( $R_{\theta JA}$ ) for the mountings shown is to be used as typical guideline values for preliminary engineering or in case the tie point temperature cannot be measured.

TYPICAL VALUES FOR  $R_{\theta JA}$  IN STILL AIR

Mounting Method	$R_{\theta JA}$	Lead Length, L (IN)				Units
		1/8	1/4	1/2	3/4	
1		50	51	53	55	°C/W
2		58	59	61	63	°C/W
3		28				°C/W

MOUNTING METHOD 1

P.C. Board Where Available Copper Surface area is small.

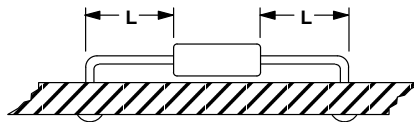

MOUNTING METHOD 2

Vector Push-In Terminals T-28

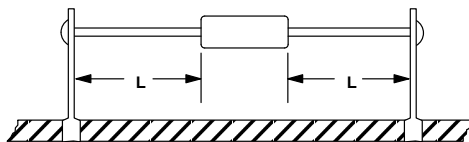

MOUNTING METHOD 3

P.C. Board with 1-1/2" x 1-1/2" Copper Surface

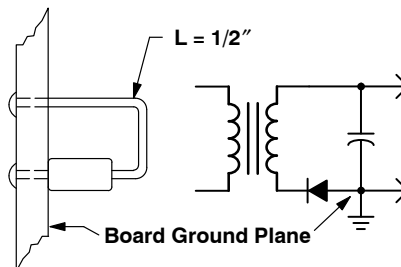

MUR550APF, MURD550PF, MUR550PF, MURF550PF

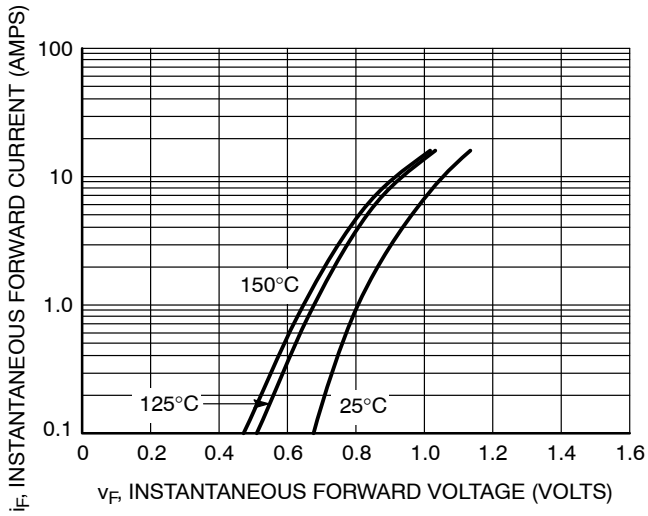

Figure 1. Typical Forward Voltage

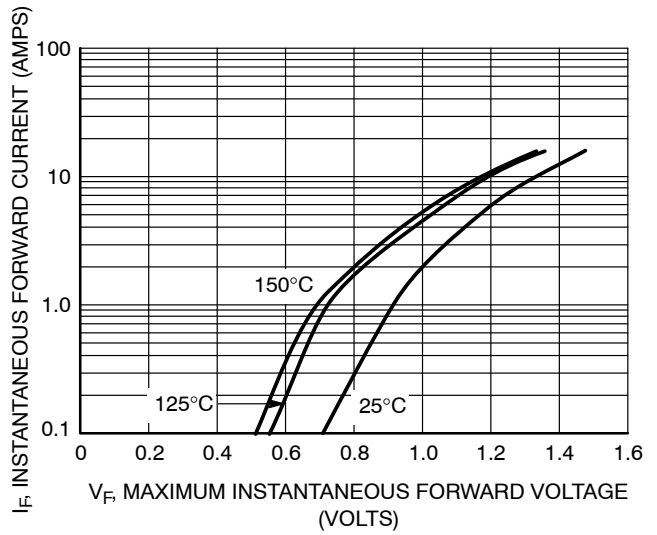

Figure 2. Maximum Forward Voltage

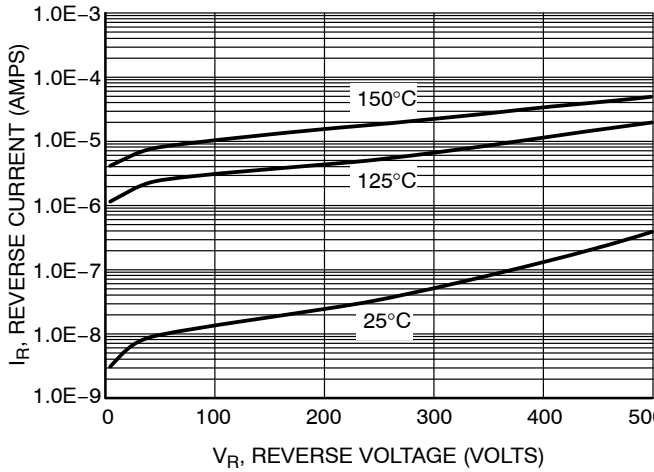

Figure 3. Typical Reverse Current

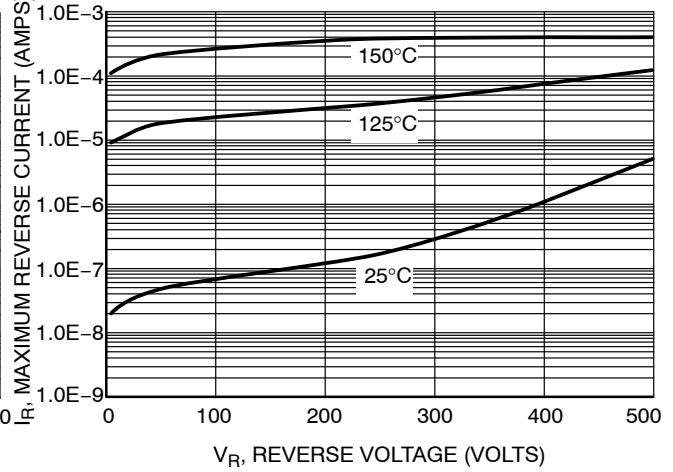

Figure 4. Maximum Reverse Current

MUR550APF, MURD550PF, MUR550PF, MURF550PF

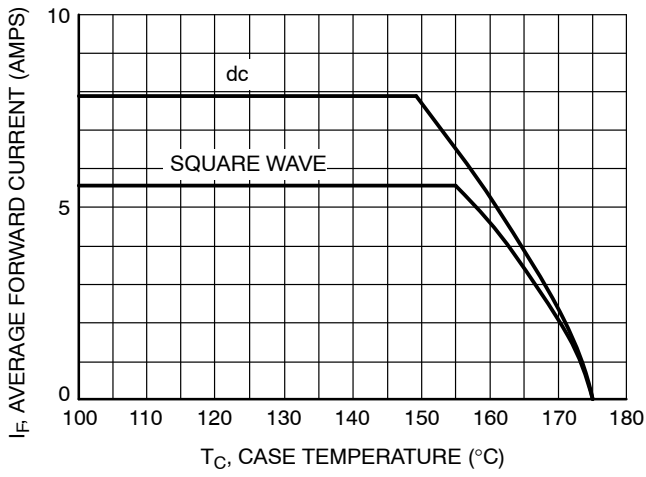

Figure 5. Current Derating

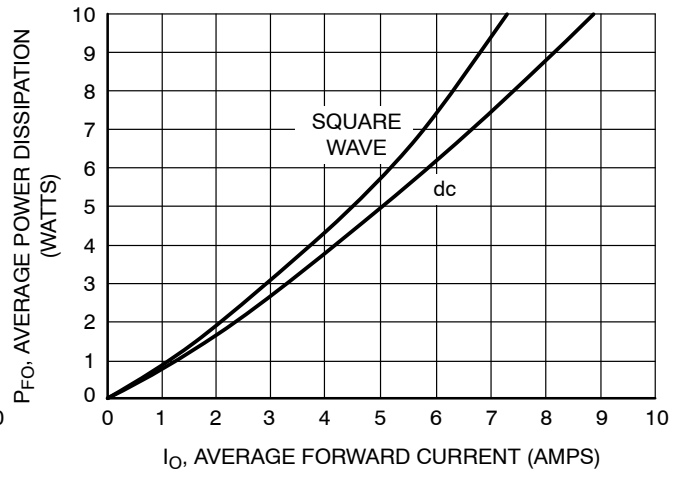

Figure 6. Forward Power Dissipation

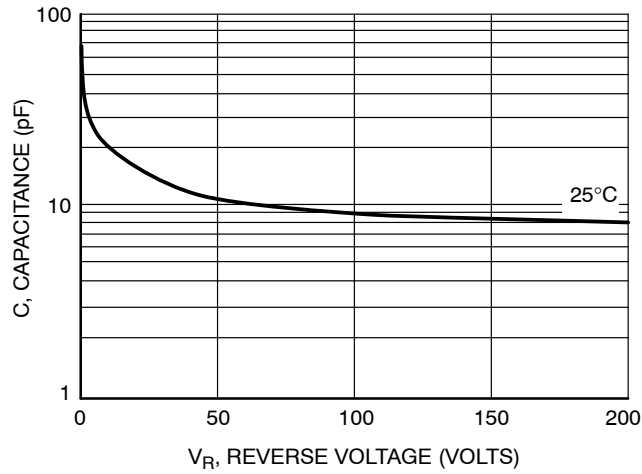

Figure 7. Capacitance

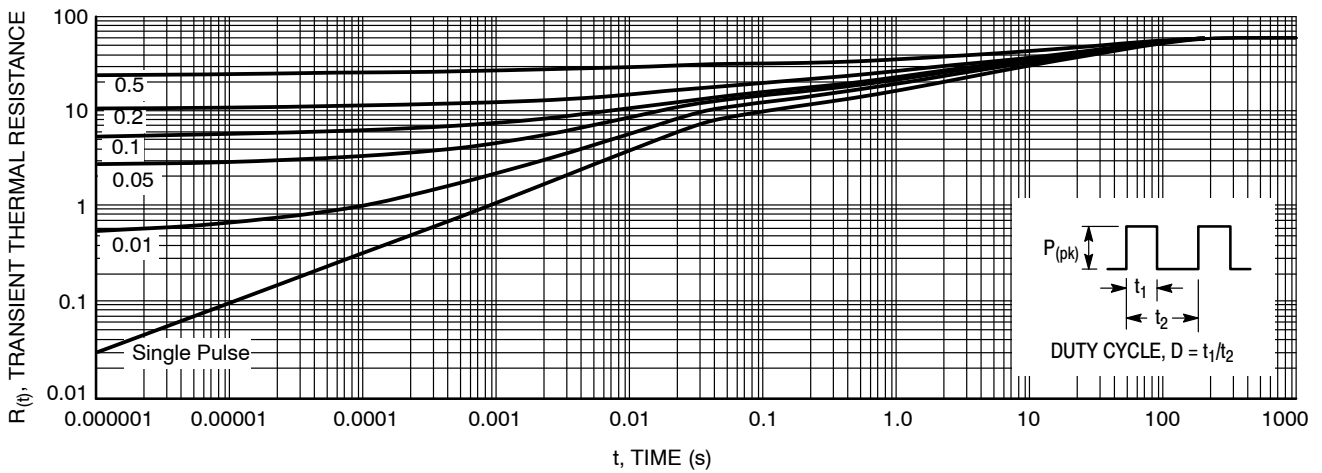

Figure 8. Thermal Response for MUR550APF

MUR550APF, MURD550PF, MUR550PF, MURF550PF

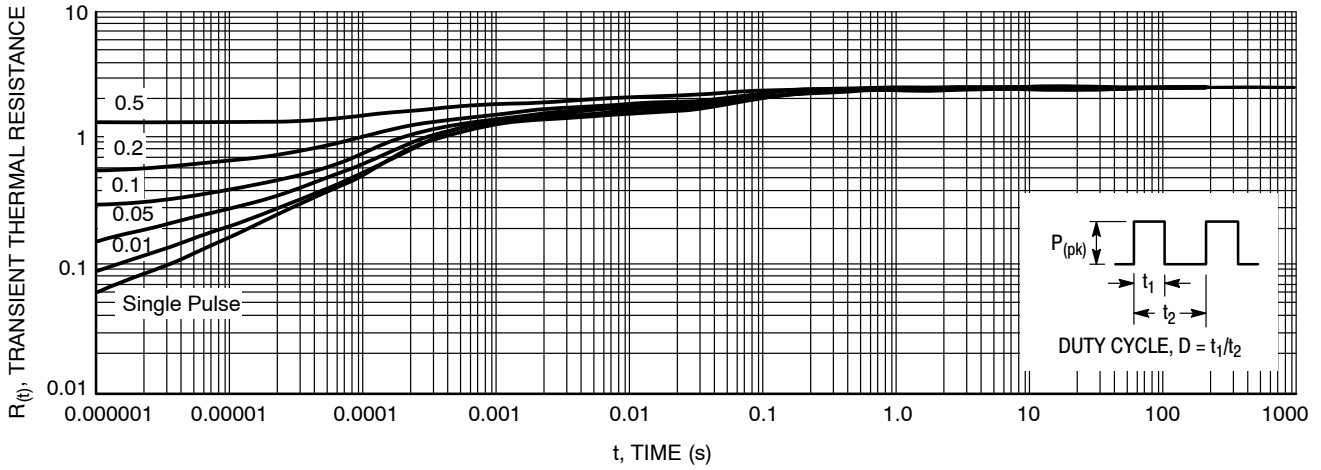

Figure 9. Thermal Response for MURD550PF

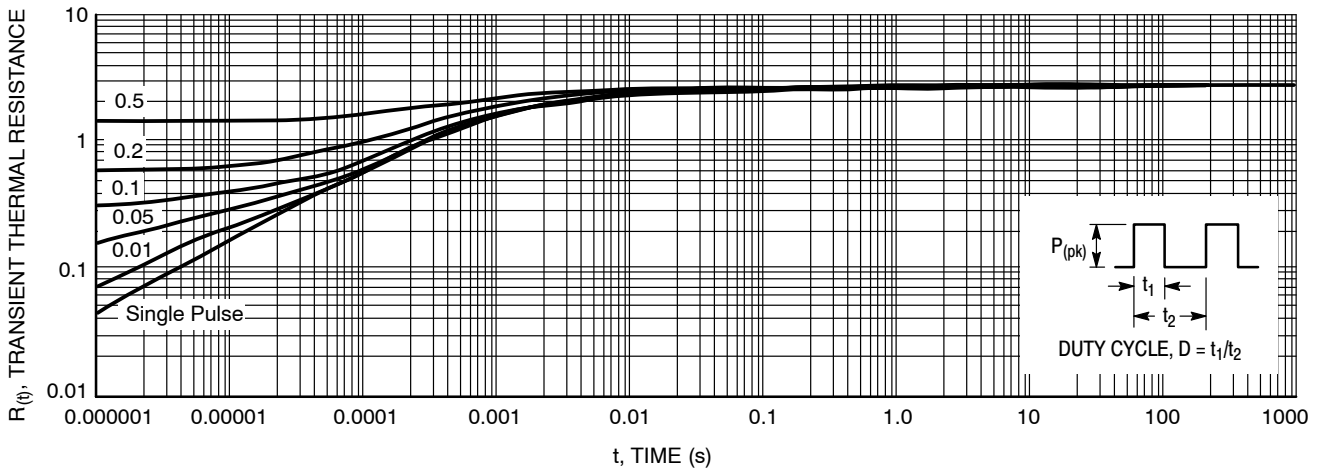

Figure 10. Thermal Response for MUR550PF

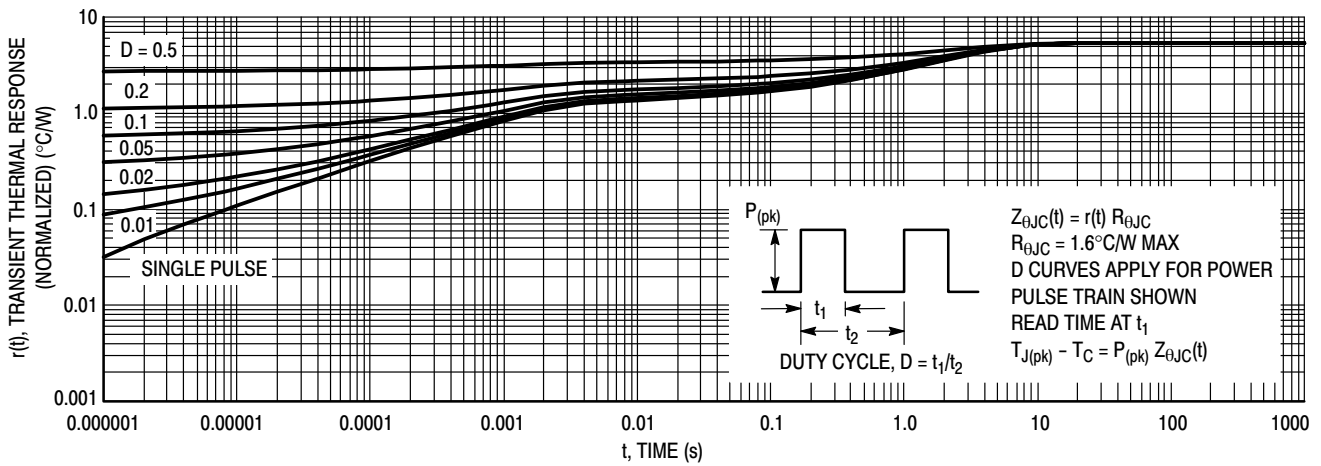

Figure 11. Thermal Response, (MURF550PF) Junction-to-Case ( $R_{\theta JC}$ )

MUR550APF, MURD550PF, MUR550PF, MURF550PF

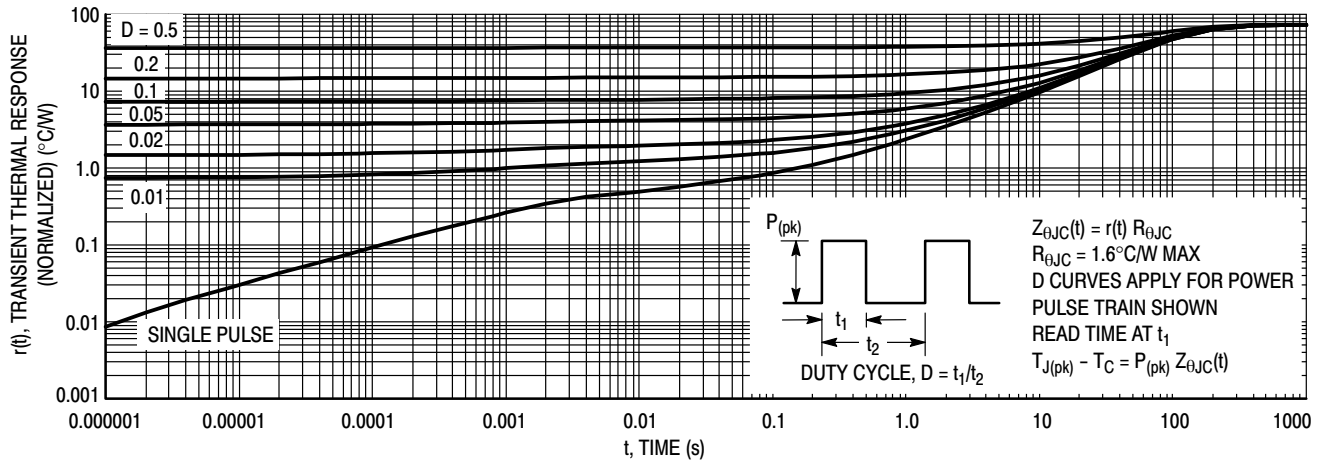
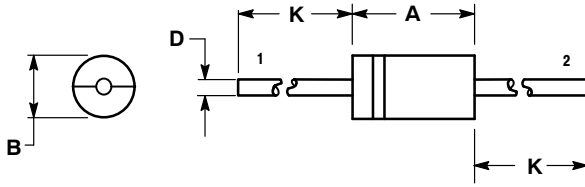

Figure 12. Thermal Response, (MURF550PF) Junction-to-Ambient ( $R_{\theta JA}$ )

# MUR550APF, MURD550PF, MUR550PF, MURF550PF

## PACKAGE DIMENSIONS

### AXIAL LEAD CASE 267-05 ISSUE G



NOTES:

1. DIMENSIONS AND TOLERANCING PER ANSI Y14.5M, 1982.
2. CONTROLLING DIMENSION: INCH.
3. 267-04 OBSOLETE, NEW STANDARD 267-05.

DIM	INCHES		MILLIMETERS	
	MIN	MAX	MIN	MAX
A	0.287	0.374	7.30	9.50
B	0.189	0.209	4.80	5.30
D	0.047	0.051	1.20	1.30
K	1.000	---	25.40	---

STYLE 1:

- PIN 1. CATHODE (POLARITY BAND)
- ANODE

### DPAK CASE 369C-01 ISSUE A

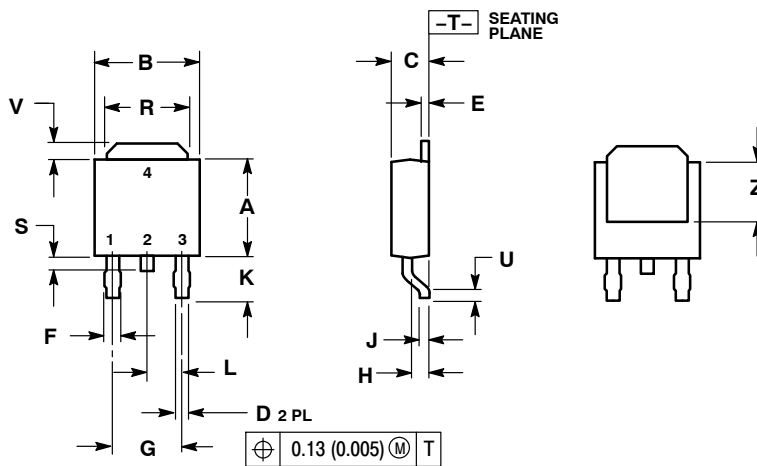

NOTES:

1. DIMENSIONING AND TOLERANCING PER ANSI Y14.5M, 1982.
2. CONTROLLING DIMENSION: INCH.

DIM	INCHES		MILLIMETERS	
	MIN	MAX	MIN	MAX
A	0.235	0.245	5.97	6.22
B	0.250	0.265	6.35	6.73
C	0.086	0.094	2.19	2.38
D	0.027	0.035	0.69	0.88
E	0.018	0.023	0.46	0.58
F	0.037	0.045	0.94	1.14
G	0.180 BSC	---	4.58 BSC	---
H	0.034	0.040	0.87	1.01
J	0.018	0.023	0.46	0.58
K	0.102	0.114	2.60	2.89
L	0.090 BSC	---	2.29 BSC	---
R	0.180	0.215	4.57	5.45
S	0.025	0.040	0.63	1.01
U	0.020	---	0.51	---
V	0.035	0.050	0.89	1.27
Z	0.155	---	3.93	---

STYLE 8:

- PIN 1. N/C
- CATHODE
- ANODE
- CATHODE

### SOLDERING FOOTPRINT\*

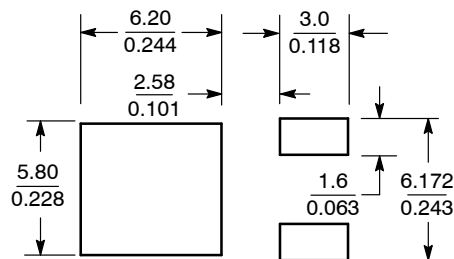

SCALE 3:1  $\left( \frac{\text{mm}}{\text{inches}} \right)$

\*For additional information on our Pb-Free strategy and soldering details, please download the ON Semiconductor Soldering and Mounting Techniques Reference Manual, SOLDERRM/D.



# MUR550APF, MURD550PF, MUR550PF, MURF550PF

## PACKAGE DIMENSIONS

### TO-220 TWO-LEAD CASE 221B-04 ISSUE E

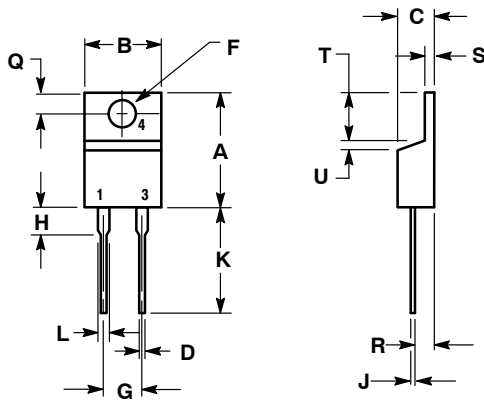

- NOTES:  
1. DIMENSIONING AND TOLERANCING PER ANSI Y14.5M, 1982.  
2. CONTROLLING DIMENSION: INCH.

DIM	INCHES		MILLIMETERS	
	MIN	MAX	MIN	MAX
A	0.595	0.620	15.11	15.75
B	0.380	0.405	9.65	10.29
C	0.160	0.190	4.06	4.82
D	0.025	0.035	0.64	0.89
F	0.142	0.161	3.61	4.09
G	0.190	0.210	4.83	5.33
H	0.110	0.130	2.79	3.30
J	0.014	0.025	0.36	0.64
K	0.500	0.562	12.70	14.27
L	0.045	0.060	1.14	1.52
Q	0.100	0.120	2.54	3.04
R	0.080	0.110	2.04	2.79
S	0.045	0.055	1.14	1.39
T	0.235	0.255	5.97	6.48
U	0.000	0.050	0.000	1.27

- STYLE 1:  
PIN 1. CATHODE  
2. N/A  
3. ANODE  
4. CATHODE

### TO-220 FULLPAK, 2-LEAD CASE 221E-01 ISSUE A

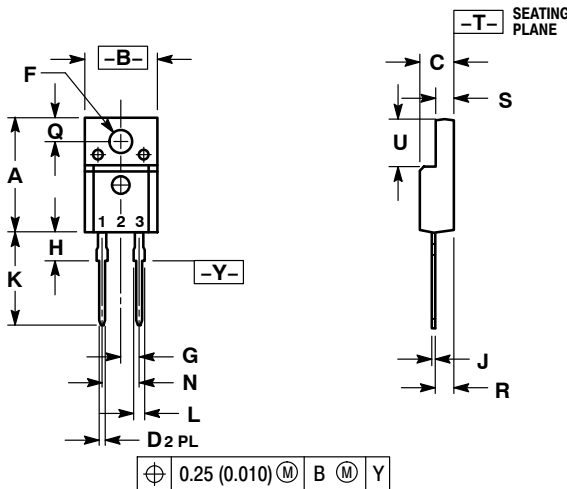

- NOTES:  
1. DIMENSIONING AND TOLERANCING PER ANSI Y14.5M, 1982.  
2. CONTROLLING DIMENSION: INCH.

DIM	INCHES		MILLIMETERS	
	MIN	MAX	MIN	MAX
A	0.617	0.633	15.67	16.07
B	0.392	0.408	9.96	10.36
C	0.177	0.193	4.50	4.90
D	0.024	0.039	0.60	1.00
F	0.121	0.129	3.08	3.28
G	0.100 BSC		2.54 BSC	
H	0.117	0.133	2.98	3.38
J	0.018	0.025	0.45	0.64
K	0.499	0.562	12.68	14.27
L	0.045	0.060	1.14	1.52
N	0.200 BSC		5.08 BSC	
Q	0.122	0.138	3.10	3.50
R	0.101	0.117	2.56	2.96
S	0.092	0.108	2.34	2.74
U	0.255	0.271	6.48	6.88

- STYLE 1:  
PIN 1. CATHODE  
2. N/A  
3. ANODE

SWITCHMODE is a trademark of Semiconductor Components Industries, LLC (SCILLC).

**ON Semiconductor** and **ON** are registered trademarks of Semiconductor Components Industries, LLC (SCILLC). SCILLC reserves the right to make changes without further notice to any products herein. SCILLC makes no warranty, representation or guarantee regarding the suitability of its products for any particular purpose, nor does SCILLC assume any liability arising out of the application or use of any product or circuit, and specifically disclaims any and all liability, including without limitation special, consequential or incidental damages. "Typical" parameters which may be provided in SCILLC data sheets and/or specifications can and do vary in different applications and actual performance may vary over time. All operating parameters, including "Typicals" must be validated for each customer application by customer's technical experts. SCILLC does not convey any license under its patent rights nor the rights of others. SCILLC products are not designed, intended, or authorized for use as components in systems intended for surgical implant into the body, or other applications intended to support or sustain life, or for any other application in which the failure of the SCILLC product could create a situation where personal injury or death may occur. Should Buyer purchase or use SCILLC products for any such unintended or unauthorized application, Buyer shall indemnify and hold SCILLC and its officers, employees, subsidiaries, affiliates, and distributors harmless against all claims, costs, damages, and expenses, and reasonable attorney fees arising out of, directly or indirectly, any claim of personal injury or death associated with such unintended or unauthorized use, even if such claim alleges that SCILLC was negligent regarding the design or manufacture of the part. SCILLC is an Equal Opportunity/Affirmative Action Employer. This literature is subject to all applicable copyright laws and is not for resale in any manner.

## PUBLICATION ORDERING INFORMATION

**LITERATURE FULFILLMENT:**  
Literature Distribution Center for ON Semiconductor  
P.O. Box 5163, Denver, Colorado 80217 USA  
**Phone:** 303-675-2175 or 800-344-3860 Toll Free USA/Canada  
**Fax:** 303-675-2176 or 800-344-3867 Toll Free USA/Canada  
**Email:** orderlit@onsemi.com

**N. American Technical Support:** 800-282-9855 Toll Free  
USA/Canada  
**Europe, Middle East and Africa Technical Support:**  
Phone: 421 33 790 2910  
**Japan Customer Focus Center**  
Phone: 81-3-5773-3850

**ON Semiconductor Website:** [www.onsemi.com](http://www.onsemi.com)  
**Order Literature:** <http://www.onsemi.com/orderlit>  
For additional information, please contact your local Sales Representative